

Linea 5 Arredamenti - Milan

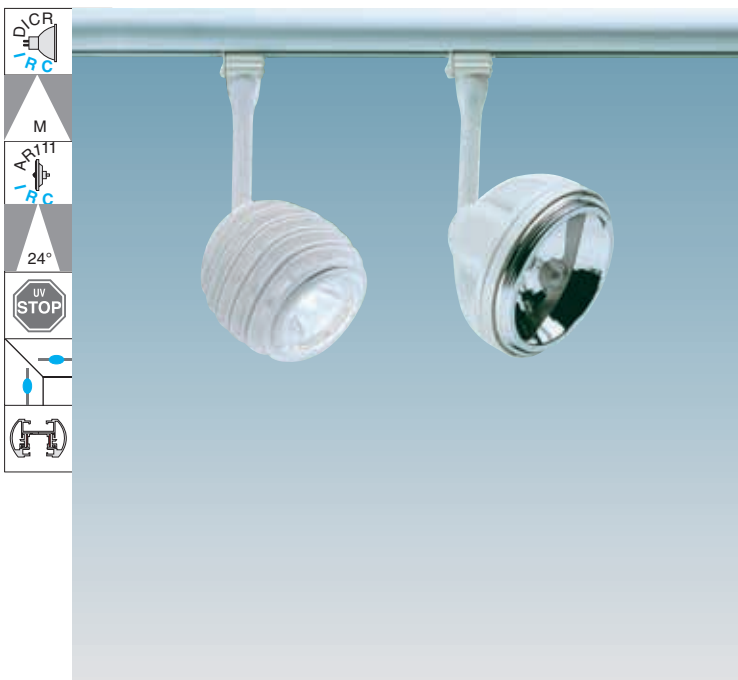

Habitat l'Arcobaleno - Milan



base	Volt	lamp	weight kg	colour	Code Fosnova
------	------	------	--------------	--------	-----------------

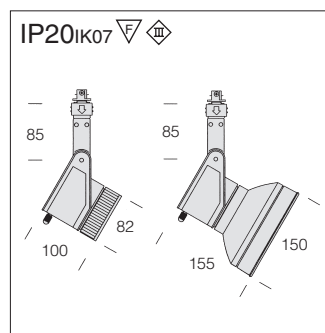
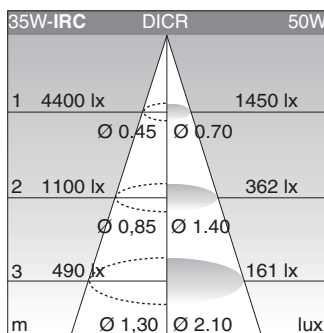

Cast 12 Volt					S+L
GX5.3	35	DICR-IRC	0,5	white	600118
GX5.3	35	DICR-IRC	0,5	m. silver	600173
GX5.3	50	DICR	0,5	white	600114
GX5.3	50	DICR	0,5	m. silver	600174
G53	50	AR111-IRC	0,6	white	600416
G53	50	AR111-IRC	0,6	m. silver	600476

Low-voltage spotlight made of die-cast aluminium; supplied with lamp; transformer not included.

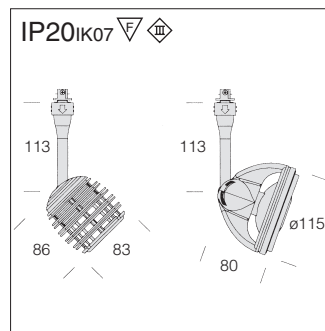
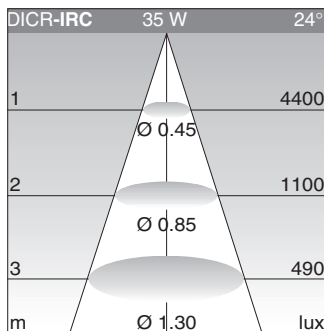

Kim2 12 Volt					S+L
GX5.3	35	DICR-IRC	0,3	white	622873
GX5.3	35	DICR-IRC	0,3	black	622833
GU5.3	50	ALU	0,3	white	632810
GU5.3	50	ALU	0,3	black	632830

Joy 12 Volt					S+L
G53	35	AR111-IRC	0,4	white	610110
G53	35	AR111-IRC	0,4	black	610131

Plastic material low-voltage spotlight supplied with lamp, transformer not included. AR111-IRC lamps help save energy with a 33% increase in luminous efficiency over traditional AR111 lamps - in a word: more light, less energy!

Plutone Accessories

Track power supply

white	24120
black	20120

To be inserted into accessories for current flow.

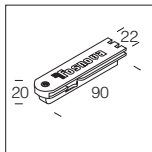

Straight joint

white	24136
black	20136

For junction of 2 tracks. To be used with 2 acc. 24120-20120.

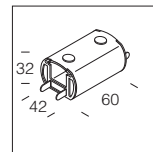

Ceiling connection

white	5325
black	5225

For direct ceiling installation. Max load: 6 kg. Always use 2 pcs.

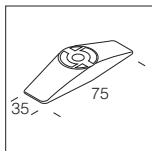

"T" joint

white	24160
black	20160

For junction of 3 tracks. To be used with 3 acc. 24120-20120.

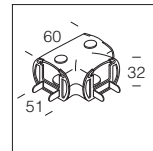

End cap

white	24021
black	23021

End cap for track.

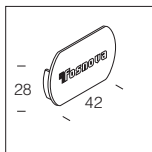

90° joint

white	24240
black	20140

For "L" junction of 2 tracks. To be used with 2 acc. 24120-20120

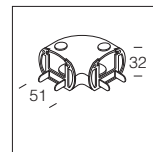

Ceiling suspension

black	3106
white	3186

With steel wire (l=1,5m), millimetre adjustment device. Max load: 20 kg. To be used with acc.5325/5225 for suspension of Plutone.

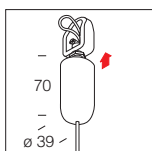

"X" joint

white	24180
black	20180

For junction of 4 tracks. To be used with 4 acc. 24120-20120.

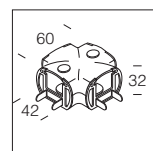

Powered ceiling suspension

black	3107
white	3187

Complete with steel wire (l=1,5m), millimetre adjustment device and power supply cable (max 2000 W). Max load: 20 kg.

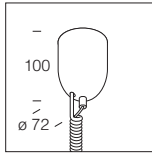

Joint for variable corners

black	25036
-------	--------------

For variable angle connection. To be used with 2 acc. 24120-20120.

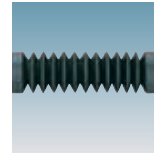
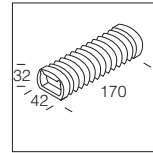

Suspension wire

steel	5226
-------	-------------

In steel wire. For suspension.

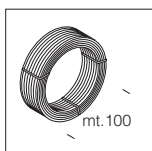

Anti-glare shutter Ømm82

black	5229
-------	-------------

In steel. Used to shield the light beam. For DICR.

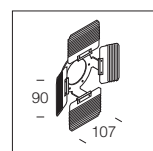

Adapter

white	24127
black	20127

Max 6 A.

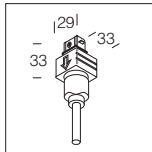

Anti-glare shutter Ømm150

black	5230
-------	-------------

In steel. Used to shield the light beam. For AR111.

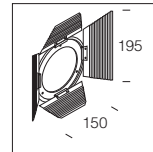

Electronic transformer 250W

black	90850
white	90851

Complete with power supply. High conductivity new contacts, thermic protection of maximum load.

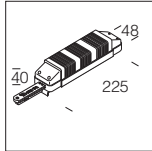

Kit

2 rods cm 40	5411	5431
2 rods cm 80	5414	5434
5 spots Kim2	632810	632830
1 transformer 250W	90851	90850
1 powered susp.	3187	3107
1 low voltage track	11313	11334

Choose rod size (40 or 80cm).

Conveyor Ø 150 mm

white	5221
black	5231

In steel. To direct the light beam in one direction.

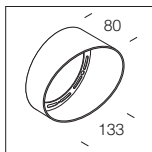

Rods

white	cm.40	5411
black	cm.40	5431
white	cm.80	5414
black	cm.80	5434

Die-cast hooks and aluminium rod for fixed mounting on casting. Max load 10 kg each.

