

Housing: in sheet steel, pressed in one piece.

Reflector: in steel, white coated.

Diffuser: in polycarbonate with prismatic faceting inside, both with smooth anti-dust external surfaces and V2 self-extinguishing UV-stabilised.

601 Disanlens - polycarbonate diffuser

wattage	colour	CNR		CEL		CNR-E		CEL-D	
		weight	code	weight	code	weight	code	weight	code
FL 1x18	white	1.70	115570-00	1.50	115570-08				
FL 1x36	white	2.65	115571-00	2.45	115571-08	3.45	115571-07		
FL 2x18	white	2.50	115572-00	2.30	115572-08				
FL 2x36	white	4.70	115573-00	4.20	115573-08	5.70	115573-07	4.20	115573-52
FL 2x58	white	6.60	115574-00	5.30	115574-08	7.60	115574-07	5.30	115574-52

Fixtures ideal for school buildings, according to EN 12464 standards.

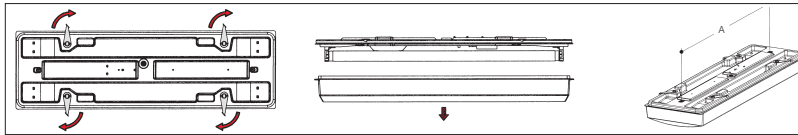

Ceiling fixture measur.:

- FL 1x18= 86 x 652
- FL 2x18= 200 x 665
- FL 1x36= 86 x 1262
- FL 2x36= 200 x 1273
- FL 2x58= 200 x 1573

Spacing for ceiling mounting (A):

- FL 1x18= 400 mm
- FL 2x18= 550 mm
- FL 1x36= 740 mm
- FL 2x36= 1080 mm
- FL 2x58= 1080 mm

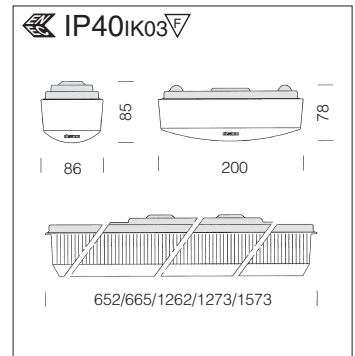
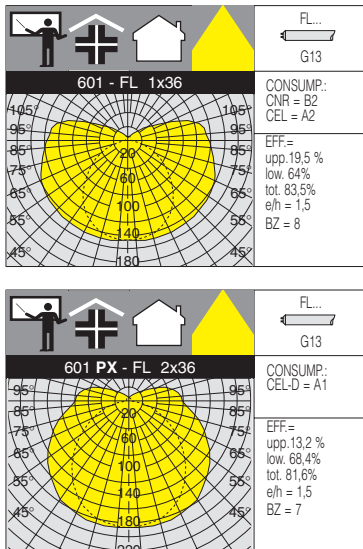

Housing: in sheet steel, pressed in one piece.

Reflector: in steel, white coated.

Diffuser: in polycarbonate with prismatic faceting inside, both with smooth anti-dust external surfaces

601 Disanlens - plexiglass diffuser

wattage	colour	CNR		CEL		CNR-E		CEL-D	
		weight	code	weight	code	weight	code	weight	code
FL 1x18	white	1.70	116070-00	1.20	116070-08				
FL 1x36	white	2.65	116071-00	2.15	116071-08				
FL 2x18	white	2.50	116072-00	2.00	116072-08				
FL 2x36	white	4.70	116073-00	4.20	116073-08	5.70	116073-07	4.20	116073-52
FL 2x58	white	6.60	116074-00	6.30	116074-08	7.60	116074-07	5.30	116074-52

Fixtures ideal for school buildings, according to EN 12464 standards.

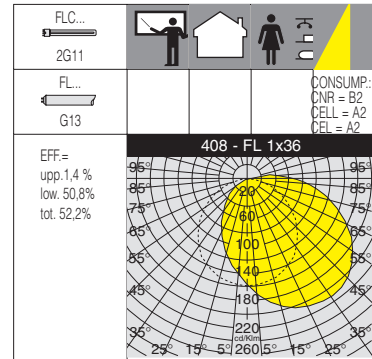
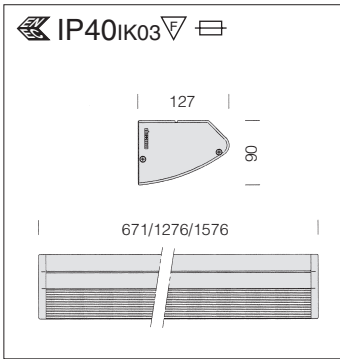

Knock-out facility fitted to the ends permits installation in continuous lines if desired.



Housing: Extruded aluminium with die-cast aluminium end caps.

Diffuser: Dust-proof, anti-glare smooth Plexiglass.

Reflector: Made of high gloss profiled aluminium; high luminous efficiency.

Coating: With UV-stabilised white epoxy polyester powder.

Electric gear: 230V/50Hz (CNR) power supply. Hard wire, cross section 0.50 sqmm, and high-temperature resistant (up to 90°C) PVC-HT sheath, in accordance with CEI 20-20 standards. 2P+T terminal block (maximum allowed lead cross section 2.5 sqmm.).

408 Wing - direct or indirect light							
		CNR-F		CELL-F		CEL-F	
wattage	colour	weight	code	weight	code	weight	code
FL 1x18	white	2.10	214320-00			1.80	214320-08
FL 2x18	white	2.50	214321-00			2.00	214321-08
FL 1x36	white	2.80	214322-00			2.10	214322-08
FL 2x36	white	3.20	214323-00			2.70	214323-08
FL 1x58	white	3.00	214324-00			2.50	214324-08
FL 2x58	white	3.60	214325-00			3.00	214325-08
FLC 2x55L	white			2.30	214327-00		

Length indirect light fixtures

- 1/2 x 18 W L_i = 671 mm
- 1/2 x 36 W L_i = 1276 mm
- 1/2 x 58 W L_i = 1576 mm
- 2 x 55 W L_i = 1276 mm

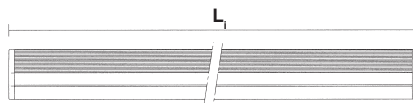

Length direct light fixtures

- 1/2 x 18 W L_d = 650 mm

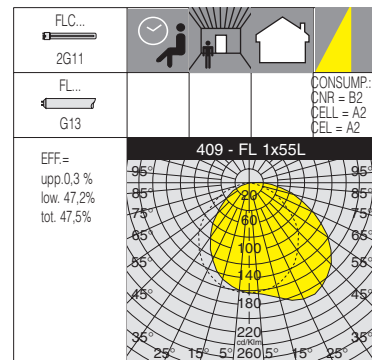
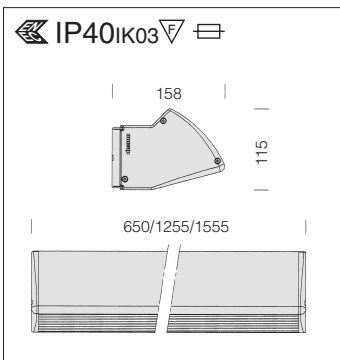
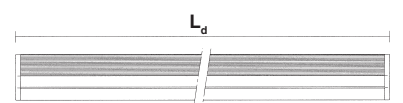

Knock-out facility fitted to the ends permits installation in continuous lines if desired.



On request: grey, yellow and cyan metallic.

409 Wing - direct or indirect light

		CNR-F		CELL-F		CNR-F-E		CEL-F	
wattage	colour	weight	code	weight	code	weight	code	weight	code
FL 1x18	white	2.10	214420-00					1.80	214420-08
FL 2x18 *	white	2.50	214421-00					2.00	214421-08
FL 1x36	white	2.80	214422-00			3.80	214422-07	2.10	214422-08
FL 2x36	white	3.20	214423-00			4.20	214423-07	2.70	214423-08
FL 1x58	white	3.00	214424-00			4.00	214424-07	2.50	214424-08
FL 2x58	white	3.60	214425-00			4.60	214425-07	3.00	214425-08
FLC 1x55L	white			2.00	214426-00				

* Standard: double circuit.