

Housing/frame: in die-cast aluminium with wide cooling fins for heat dissipation.

Base: in vandal resistant fibreglass nylon.

Diffuser: silk-screen printed, tempered.

Coating: in several stages. First stage: epoxy cationic electrocoating, resistant to corrosive and saline environments. Second stage: UV-stabilising primer, and final stage rough finish with metallic silver acrylic coating.

Electric gear: 12V power supply.

Equipment: cable gland, Ø 1/2 gas thread.

| 1536 Koala | | | | |
|-------------------|-----------|--------|-----------|------------------------------|
| | | CTL | | Lamps (Ta=25°C) |
| wattage | colour | weight | code | Kelvin - ølm - Ra |
| ALO-IRC 50 | m. silver | 2.00 | 431810-00 | 3000K - 1250lm - Ra 1a |
| DICR 50 | m. silver | 2.00 | 431811-00 | 3000K - 1500cd - 38° - Ra 1a |
| AR 70/50 | m. silver | 2.00 | 431812-00 | 3000K - 12500cd - 8° - Ra 1a |

Supplied with lamp and toroidal transformer. **Lamps ALO-IRC:** power saving lamps provide a luminous efficiency 33%. Duration (4000 hours) and better performance.
50W = 35W IRC - 75W = 50W IRC

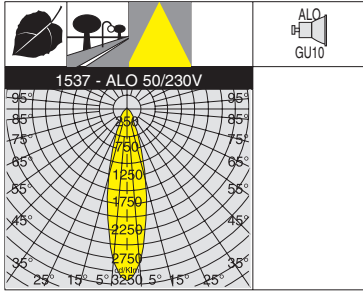

| 1537 Koala - 230 V | | | | |
|--------------------|-----------|--------|-----------|-------|
| | | S+L | | Lamps |
| wattage | colour | weight | code | |
| ALO 50 | m. silver | 1.50 | 431815-00 | 24° |

Supplied with 230V lamp; mains voltage operated without transformer.

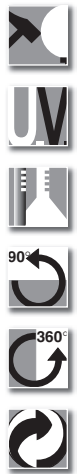
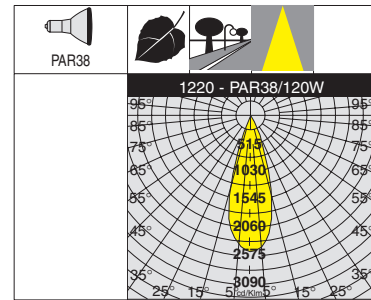
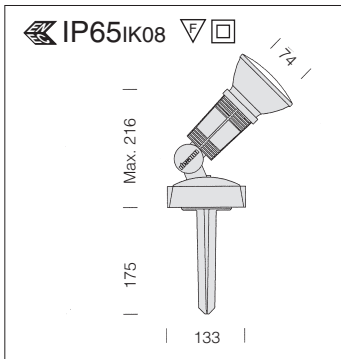

Housing/frame: in fibreglass and self-extinguishing nylon.

Equipment: Supplied with base and ground-sinking spike. Standard supply includes 2 cable glands.

Accessories: possibility of installation on acc. 116/118/120/121.

| 1220 Dafne | | | | |
|--|--------|--------|-----------|---|
| | | S | | Lamps |
| wattage | colour | weight | code | |
| PAR 38 | black | 0.30 | 431801-00 | Use PAR 38 lamp of 80W or 120W lamp only. |
| Supplied with 230V lamp; mains voltage operated without transformer. | | | | |

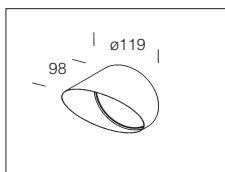

| acc. 114 conveyor | |
|---|--------|
| m. silver | 991330 |
| In aluminium. To direct the light beam in one direction. Only for art. Koala. | |

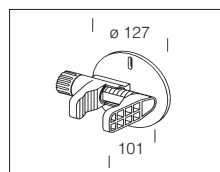

| acc. 118 clamp | |
|---|--------|
| black | 991334 |
| In fiber glass nylon. Enables Koala/Dafne to be installed on different surfaces without the need to fix it definitively. Clamp opening between 20mm (min) and 60mm (max). | |

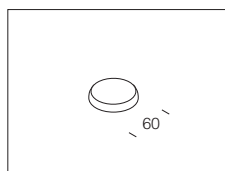

| acc. 115 pole cap | |
|--|--------|
| black | 991331 |
| In fiber glass nylon. To apply to Ø60 mm pole (acc. 50). End cap for the pole top. | |

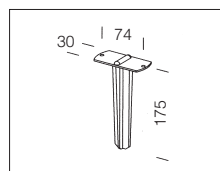

| acc. 119 spike | |
|---|--------|
| black | 991335 |
| In fiber glass nylon. For planting Koala into the ground. | |

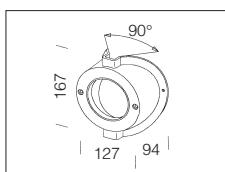

| acc. 116 corner support | |
|--|--------|
| black | 991332 |
| In fibreglass nylon. To install Koala/Dafne on a corner. | |

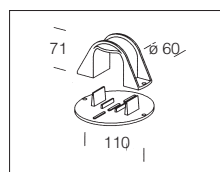

| acc. 120 pole support | |
|---|--------|
| black | 991336 |
| In fibreglass nylon. To apply Koala/Dafne on any Ø 60 pole in any position. | |

