



Housing: made of pressed steel drawn in a single, piece for high mechanical resistance.

Reflector: symmetric high-gloss aluminium 99.85, large size for higher efficiency.

Coating: sandblasted silver powder coating after a phosphochromate treatment, for better resistance to corrosion and saline environment.

Electric gear: 230V/50Hz power supply. Hard wire, cross section 0.50 sqmm, and high-temperature resistant (up to 90°C) PVC-HT sheath, in accordance with CEI 20-20 standards. 2P+T terminal block with fuse holder. Maximum allowed lead cross section 2.5 sqmm.

Equipment: 6.3A protection fuse. Environment-friendly polyurethane foam gasket. Fibreglass nylon cable gland, Ø 1/2 gas. Supplied with ceiling mounting brackets.

On request: a "Main Control System" to supervise the emergency versions (see chapter). Also, version supplied with lamp FL Extreme (working life: 35,000 h).

Emergency version: in maintained version. In the event of a blackout a single lamp connected to the back-up circuit stays on. Run time 60 minutes (see chapter). On request: versions with 3 hour emergency duration.

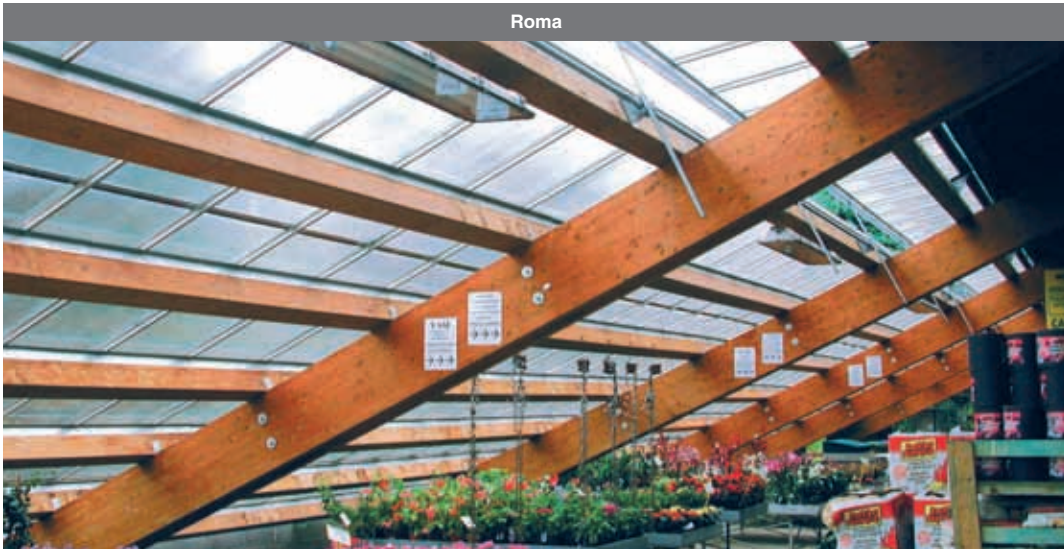

acc. 945 two lamp narrow beam reflector

2x18	998085
2x36	998086
2x58	998087
2x80	998089

Made of polished aluminium 99.85. To be applied to the reflector already supplied with the fixtures. For art. Eterna/Steel.

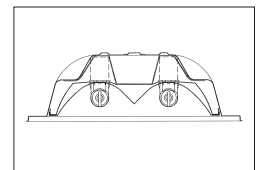
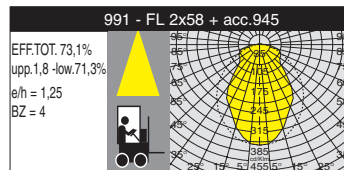
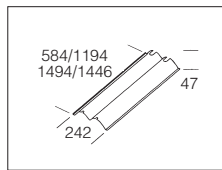

acc. 996 adjustable bracket

inox	166670
------	--------

Made of stainless steel, for art. 989-990-991-992-998. For suspension and rotation. **2 per pack.** Installation of fixtures providing indirect light with flat glass is not recommended for exterior application. For art. Eterna/Steel.

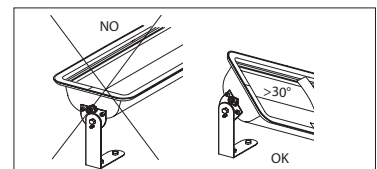
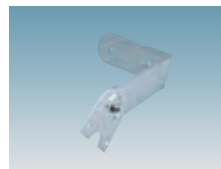
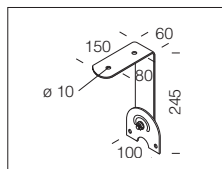

acc. 127 stainless steel bracket

inox	998079
------	--------

For FL2x18 version. For suspension installation and quick connection. Option to install a connector for electric connection. For art. Eterna/Steel.

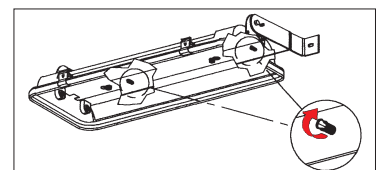
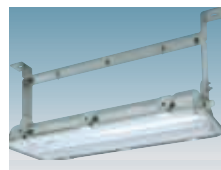
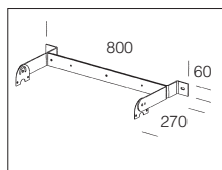

acc. 133 hook for Ø 60 tube

inox	998088
------	--------

To be used with the supplied brackets to install the fixtures on a Ø60 tube. **2 per pack.** For art. Eterna/Steel.

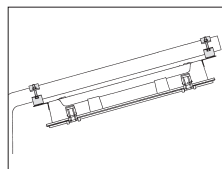

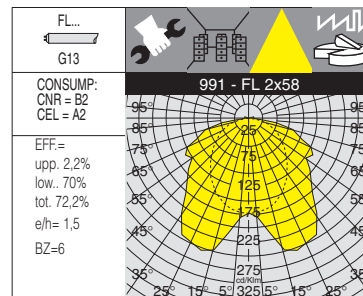
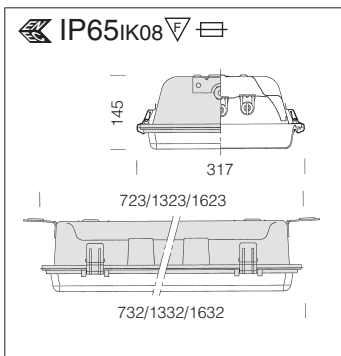

Diffuser: injection moulded, UV-stabilised, clear self-extinguishing V2 polycarbonate; prismatic inside for better light control. Installation of fixtures providing indirect light with diffuser is not recommended for exterior application.

991 Steel - steel + polycarbonate

		CNR-F		CEL-F		CNR-F-E		CELL-F		CELL-D	
wattage	colour	weight	code	weight	code	weight	code	weight	code	weight	code
FL 2x18	s. silver	5.10	162251-00	4.90	162251-08						
FL 2x36	s. silver	8.00	162252-00	7.60	162252-08	8.70	162252-07	7.60	162252-52		
FL 2x58	s. silver	11.10	162253-00	10.50	162253-08	11.70	162253-07	10.50	162253-52		
FL 3x18	s. silver	6.20	162254-00								
FL 3x36	s. silver	9.10	162255-00	8.40	162255-08	9.50	162255-07	9.10	162255-52		
FL 3x58	s. silver	12.40	162256-00	12.00	162256-08	12.60	162256-07				

NOTE: Upon request, versions FL 2/3x18 can be supplied with a quick plug-socket connector.

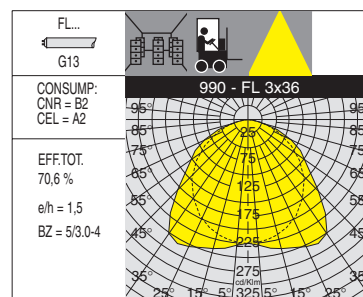
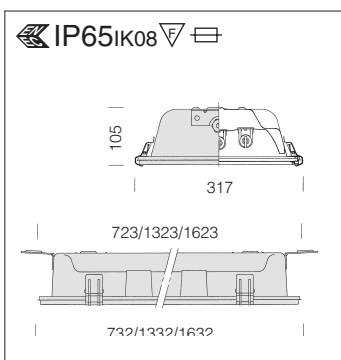

Diffuser: 5-mm thick tempered glass. The smooth outside finish facilitates cleaning, essential to ensure maximum lighting efficiency. Installation of fixtures providing indirect light with flat glass is not recommended for exterior application.

990 Steel - steel + glass

		CNR-F		CEL-F		CNR-F-E		CELL-F		CELL-D	
wattage	colour	weight	code	weight	code	weight	code	weight	code	weight	code
FL 2x18	s. silver	6.90	162151-00	6.70	162151-08						
FL 2x36	s. silver	11.80	162152-00	11.40	162152-08	12.50	162152-07			11.80	162152-52
FL 2x58	s. silver	15.90	162153-00	15.50	162153-08	16.60	162153-07			15.90	162153-52
FL 3x18	s. silver	8.00	162154-00								
FL 3x36	s. silver	12.90	162155-00	12.30	162155-08	13.40	162155-07			12.90	162155-52
FL 3x58	s. silver	17.20	162156-00	16.50	162156-08	17.60	162156-07				
FL 2x54	s. silver							11.80	162157-00		
FL 2x80	s. silver							15.90	162158-00		
FL 3x54	s. silver							12.80	162159-00		
FL 3x80	s. silver							16.90	162160-00		

NOTE: Upon request, versions FL 2/3x18 can be supplied with a quick plug-socket connector.



FLUORESCENT
WATERPROOF