



**Housing:** Extruded aluminium with die-cast end caps.

**Cover for indirect lighting:** In vandal resistant and V2 self-extinguishing polycarbonate.

**Dark light optics:** double parabolic louvres, in high-gloss plated aluminium 99.99. Anti-glare and anti-iridescence, very low luminance. PVD treatment to increase light efficiency.

**Coating:** UV-stabilized polyester resin powder coating.

**Electric gear:** 230V240-50/60 power supply.

**Cover:** Possibility of direct light using accessory 375.

**Standard supply:** Snap fastening optics, which remain attached by safety cords.

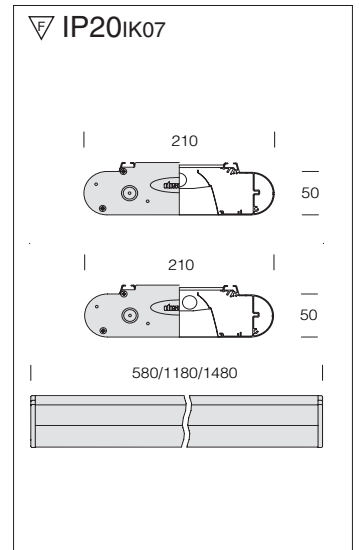
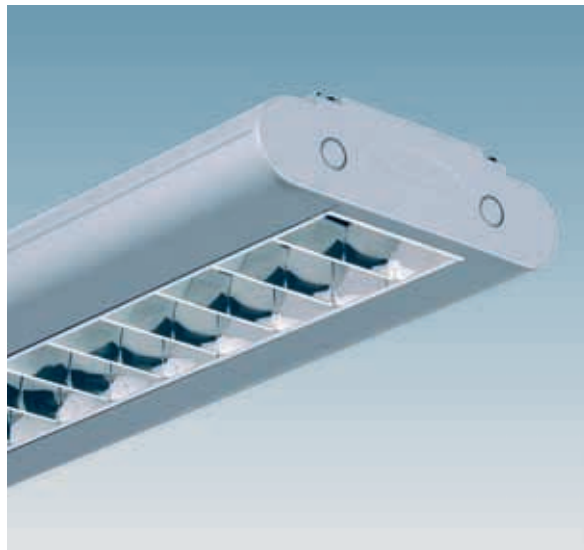
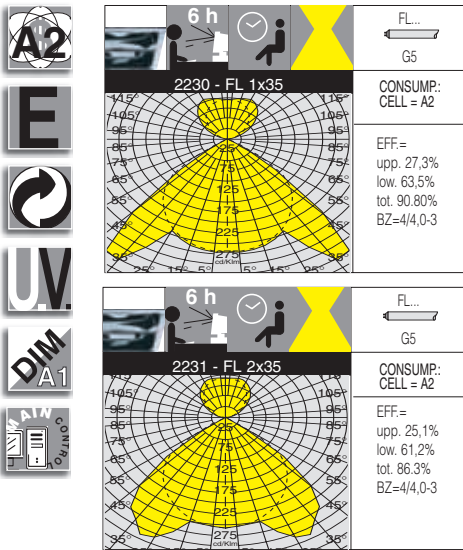

**2230 Giano 1 - T5 - single one-lamp - specular optics 99,99**

wattage	colour	CELL		CELL-E		CELL-D		Lamps (Ta=25°C) Kelvin - ølm - Ra
		weight	code	weight	code	weight	code	
FL 1x14	s. silver	2.00	143810-00					4000K - 1200lm - Ra 1b
FL 1x14	white	2.00	143805-00					4000K - 1200lm - Ra 1b
FL 1x28	s. silver	3.30	143811-00	3.90	143811-07	3.80	143811-52	4000K - 2600lm - Ra 1b
FL 1x28	white	3.30	143806-00	3.90	143806-07	3.80	143806-52	4000K - 2600lm - Ra 1b
FL 1x35	s. silver	3.90	143812-00	4.60	143812-07	4.40	143812-52	4000K - 3300lm - Ra 1b
FL 1x35	white	3.90	143807-00	4.60	143807-07	4.40	143807-52	4000K - 3300lm - Ra 1b
FL 1x49	s. silver	4.00	143813-00	4.70	143813-07	4.50	143813-52	4000K - 4300lm - Ra 1b
FL 1x49	white	4.00	143808-00	4.70	143808-07	4.50	143808-52	4000K - 4300lm - Ra 1b

**2231 Giano 2 - T5 - two-lamp - specular optics 99,99**

wattage	colour	CELL		CELL-E		CELL-D		Lamps (Ta=25°C) Kelvin - ølm - Ra
		weight	code	weight	code	weight	code	
FL 2x14	s. silver	2.00	143820-00					4000K - 1200lm - Ra 1b
FL 2x14	white	2.00	143855-00					4000K - 1200lm - Ra 1b
FL 2x28	s. silver	3.30	143821-00	4.10	143821-07	3.80	143821-52	4000K - 2600lm - Ra 1b
FL 2x28	white	3.30	143856-00	4.10	143856-07	3.80	143856-52	4000K - 2600lm - Ra 1b
FL 2x35	s. silver	3.90	143822-00	4.90	143822-07	4.40	143822-52	4000K - 3300lm - Ra 1b
FL 2x35	white	3.90	143857-00	4.90	143857-07	4.40	143857-52	4000K - 3300lm - Ra 1b
FL 2x49	s. silver	4.00	143823-00	4.90	143823-07	4.50	143823-52	4000K - 4300lm - Ra 1b
FL 2x49	white	4.00	143858-00	4.90	143858-07	4.50	143858-52	4000K - 4300lm - Ra 1b

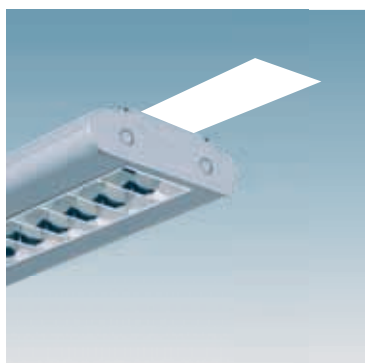

Possibility of direct light using accessory 375.

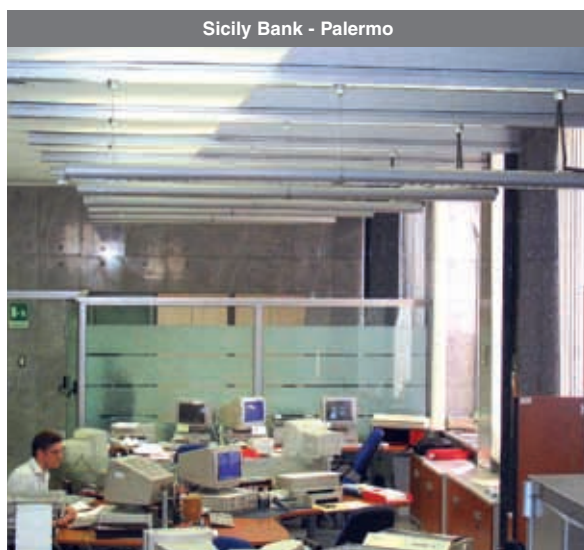

**Emergency version:** In maintained version. In the event of a black-out a single lamp connected to the back-up circuit stays on. Run time 60 minutes (see chapter). On request: versions with 3 hour emergency duration.

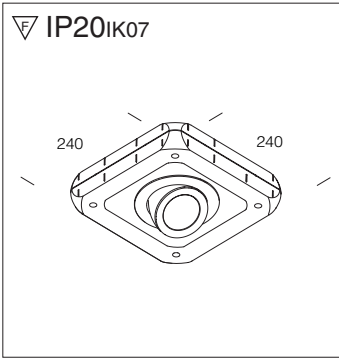

**Housing:** Made of die-cast aluminium. with adjustable floodlight aluminium.

**Mounting:** Only to system (not to be recessed).

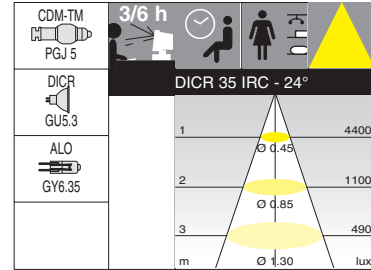

2232 Giano - cube with spot						
		CTL		CELL		Lamps (Ta=25°C)
wattage	colour	weight	code	weight	code	Kelvin - ølm - Cd - Ra
DICR35IRC	s. silver	2.00	143844-00			24° - 4400 Cd - Ra 1a
DICR35IRC	white	2.00	143850-00			24° - 4400 Cd - Ra 1a
ALO35IRC	s. silver	2.00	143846-00			24° - 900lm - Ra 1a
ALO35IRC	white	2.00	143851-00			24° - 900lm - Ra 1a
CDM-TM 20	s. silver			2.50	143848-00	3000K - 1650lm - Ra 1b
CDM-TM 20	white			2.50	143852-00	3000K - 1650lm - Ra 1b

10° to 45° spotlight tilting angle.

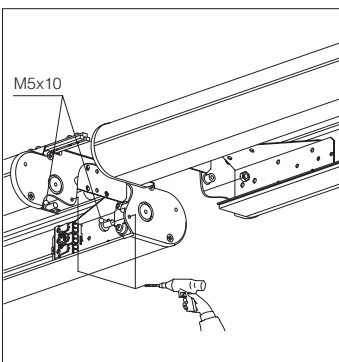

Continuous line example installation with acc. 2290.

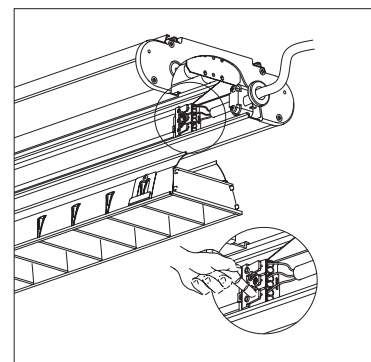
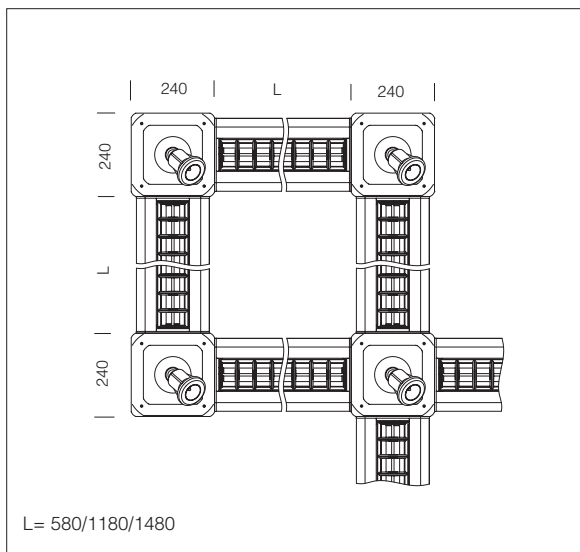

Quick connection for easy and rapid installation and maintenance.

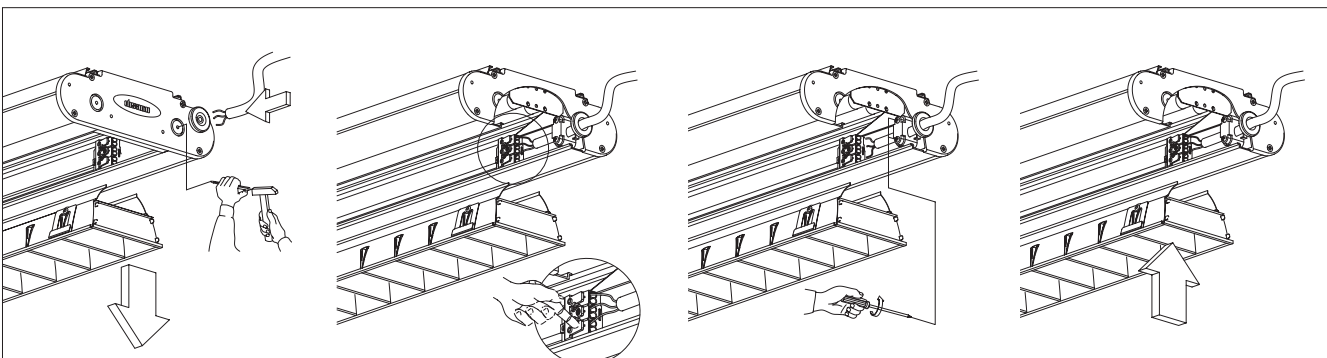



Versions complete with louvre and can be supplied with spotlight fixtures on request (174 mm larger compared to the standard versions for each spotlight be selected according to the type of use).

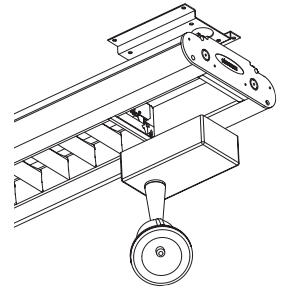

<b>acc. 2291 wall mounting unit</b>	
galvanized	143998
Galvanized sheet steel brackets. To install the lighting fixture directly onto wall surfaces. <b>2 per pack.</b>	

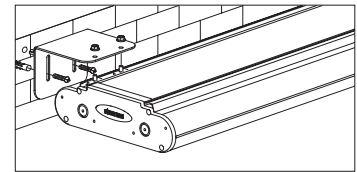
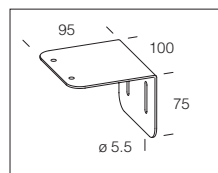
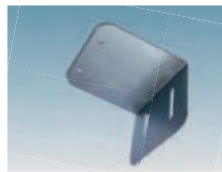

<b>acc. 2290 linear joint</b>	
zamak	143997
For linear installation. <b>2 per pack.</b>	

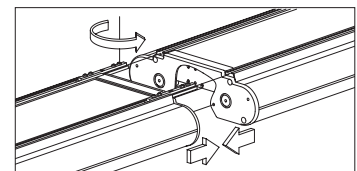
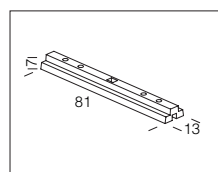

<b>acc. 376 ceiling moun. unit</b>	
galvanized	145151
For direct ceiling installation. Only for equipment with direct light. <b>2 per pack</b>	

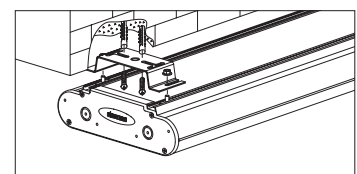
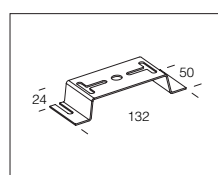

<b>acc. 377 bracket for spotlight</b>	
galvanized	145152
Bracket to be used with the "S" module to install Fosnova spotlights. The maximum number of lighting fixtures is limited by the overall weight on the suspensions. Only for spotlights with base 155 mm.	

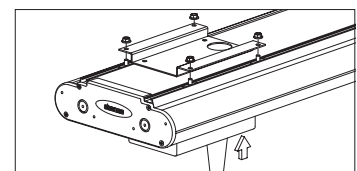
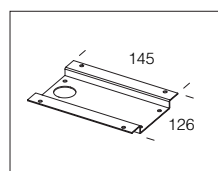
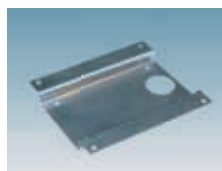

<b>acc. 2518 simple suspension</b>	
galvanized	994019
Suspension supplied with steel wire, 1.75 m long with millimetric adjustment. Max load: 20 kg.	

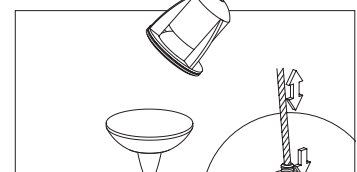
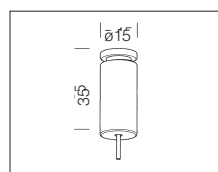

<b>acc. 2513 suspension</b>	
m. silver	993917
Suspension supplied with steel wire, 1.75 m long with millimetric adjustment. Max load: 20 kg.	

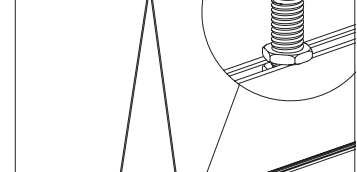
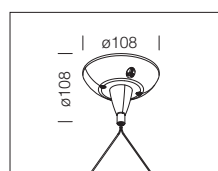
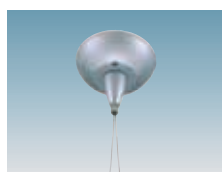

<b>acc. 2514 powered suspension</b>	
m. silver	993919
Suspension supplied with steel wire, 1.75 m long with millimetric adjustment and power cable. Max load 20 kg.	

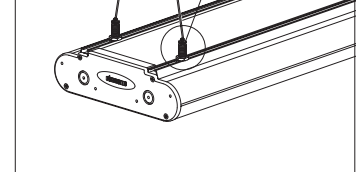
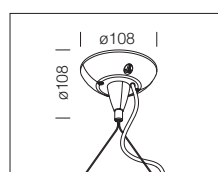

The Matrix and Sonik range spotlights can be installed using the module S2 and bracket accessories 377 (refer to Fosnova Products).

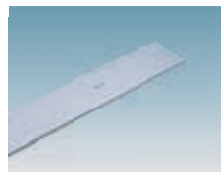
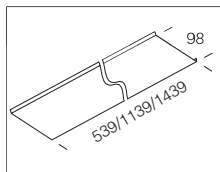
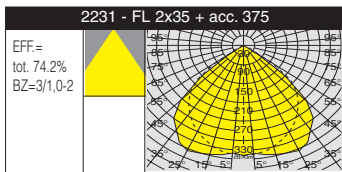

<b>acc. 375 upper cover</b>	
14 white	145148
28 white	145149
35/49 white	145150

For direct light only applications.

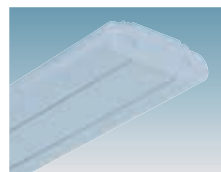
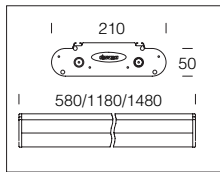

<b>acc. 390 "s1" module</b>	
14 s. silver	143828
14 white	143860
28 s. silver	143829
28 white	143861
35/49 s. silver	143830
35/49 white	143862

Extruded aluminium with die-cast end caps.

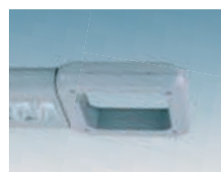
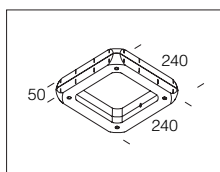

<b>acc. 392 simple cube</b>	
s. silver	143840
white	143868

Made of die-cast aluminium and powder-coated.  
For "L", "T" o "X" jointing.

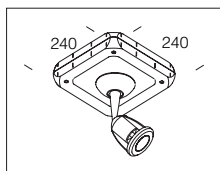

<b>acc. 393 cube for floodlights</b>	
s. silver	143842
white	143869

Made of die-cast aluminium. For "L", "T" o "X" jointing and application of Fosnova spotlights.

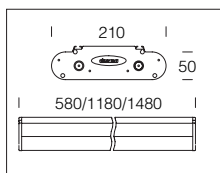

<b>acc. 391 "s2" module</b>	
14 s. silver	143834
14 white	143865
28 s. silver	143835
28 white	143866
35/49 s. silver	143836
35/49 white	143867

To install Matrix and Sonik range spotlights with bracket access. 377 (refer to Fosnova Products).